









 Ø6,3x50 mm A1 x 54	 Ø12 mm A2 x 54	 4 mm A3 x 1	 Ø15x12 mm B1 x 18	 Ø5x44 mm B2 x 18
 Ø20 mm B3 x 18	 Ø4x16 mm D1 x 72	 Ø3x25 mm D2 x 6	 Ø1,6x25 mm F x 204	 Ø8x36 mm G x 51
 K x 6	 N x 5	 745 mm O1 x 2	 Z x 6	

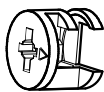
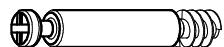

Box 1/3

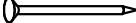
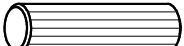
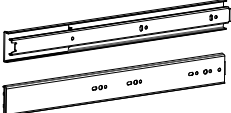
747x424x16 mm

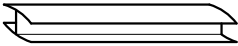

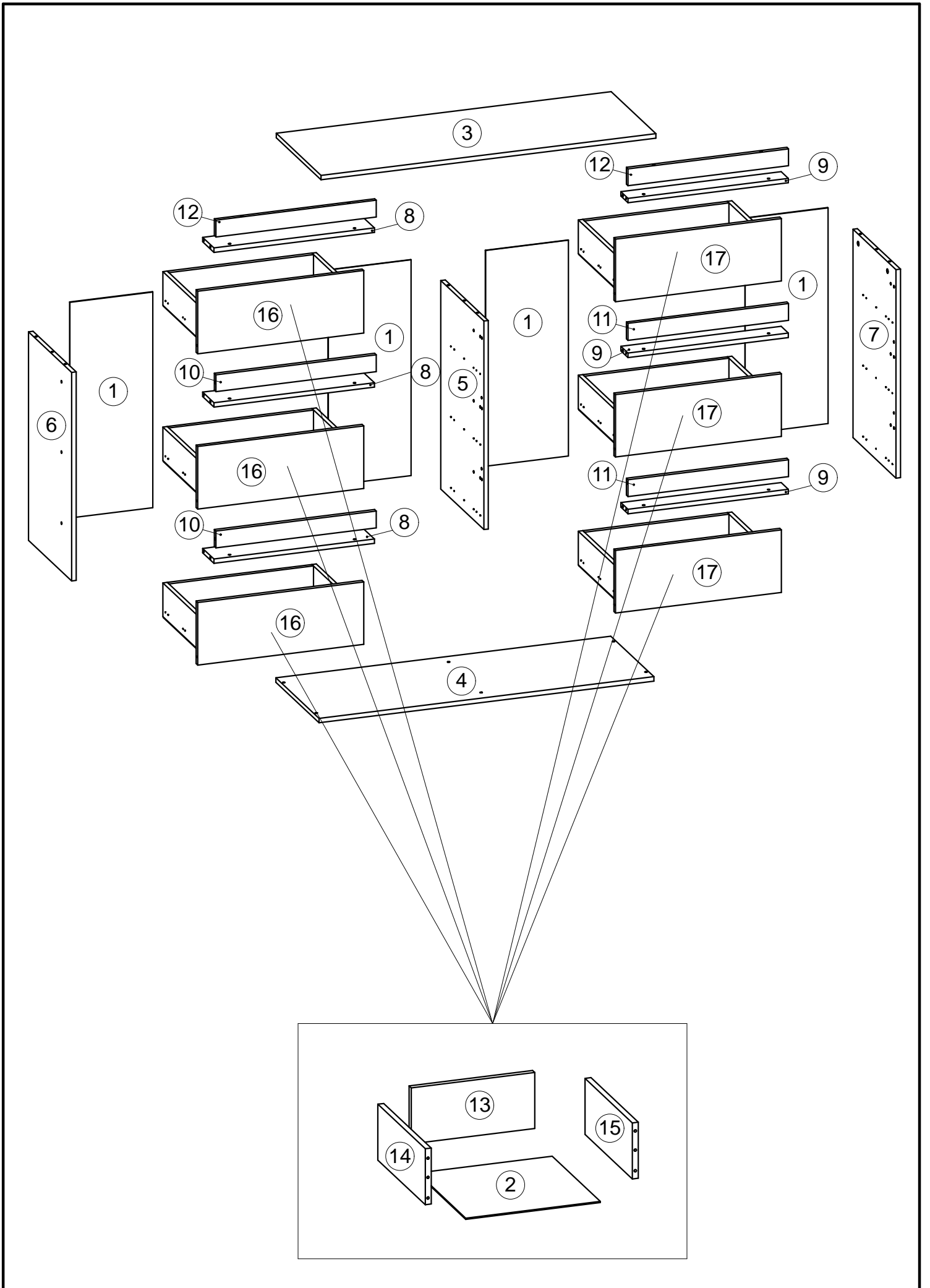
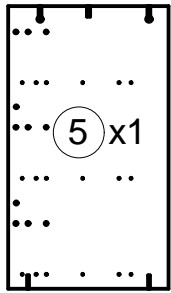
747x424x16 mm

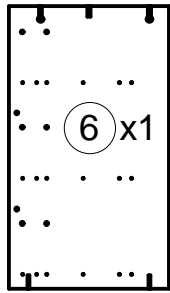

747x424x16 mm

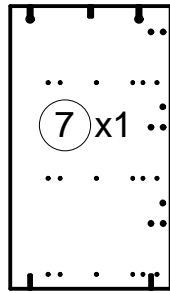

400x120x16 mm

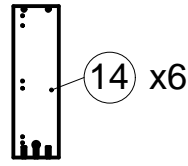

400x120x16 mm

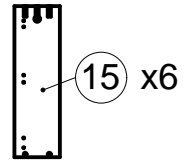

Fittings & Tools

Box 2/3

773x297x3 mm

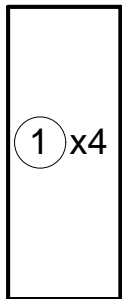

548x406x3 mm

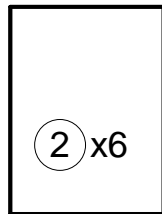

1199x440x16 mm

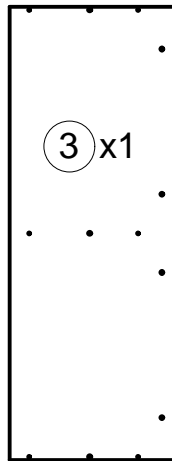

1199x424x16 mm

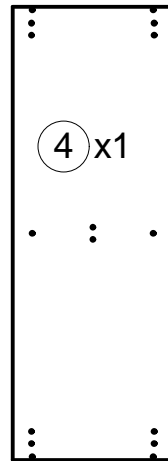

575x110x16 mm

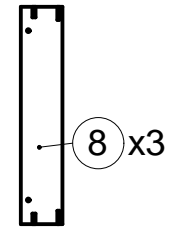

60x575x16 mm

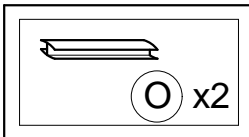
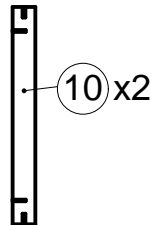

575x70x16 mm

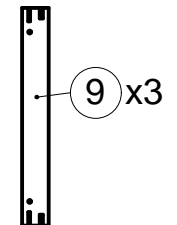

60x575x16 mm

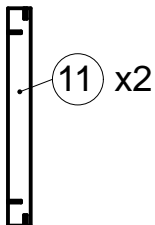

60x575x16 mm

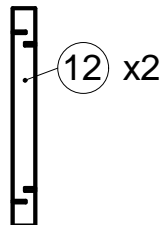

518x120x16 mm

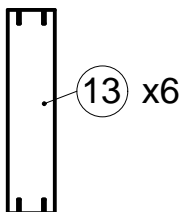

Box 3/3

223x594x16 mm

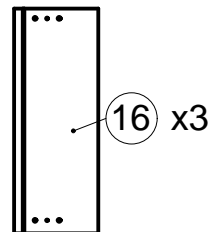

223x594x16 mm

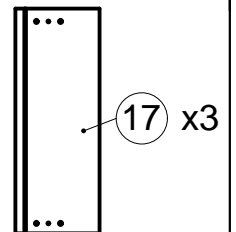

1

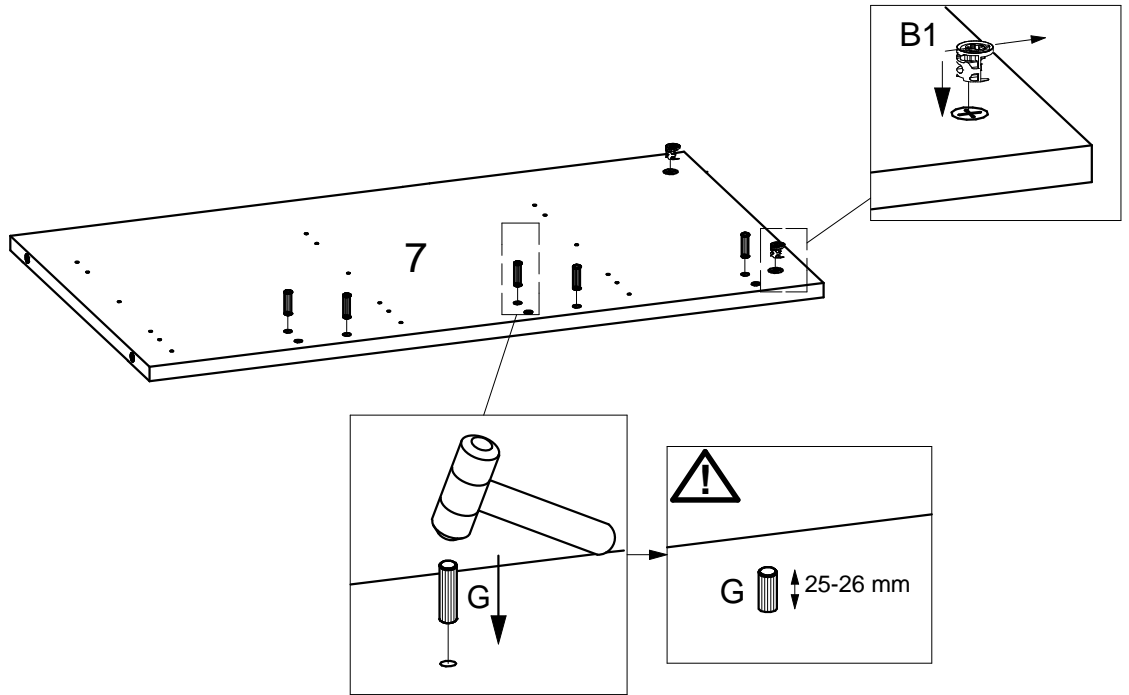
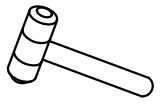
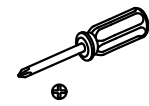
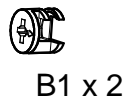
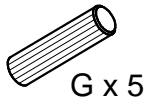

2

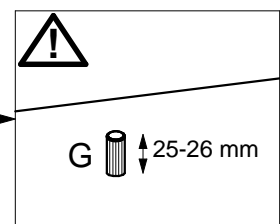
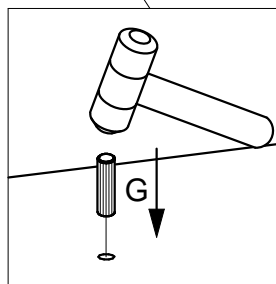
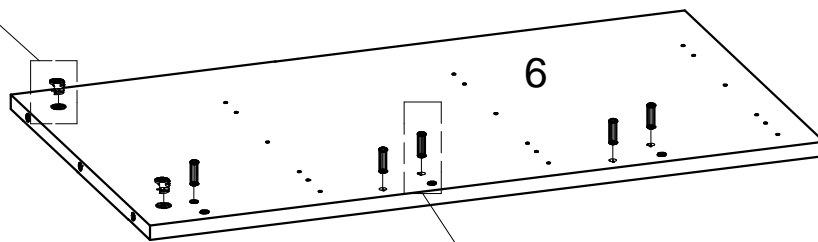
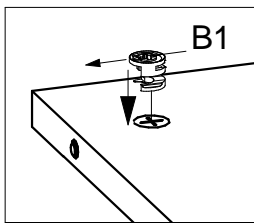
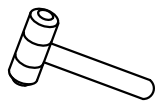
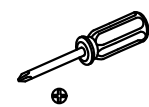
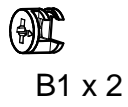
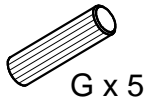

3

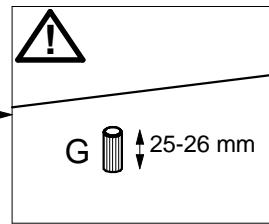
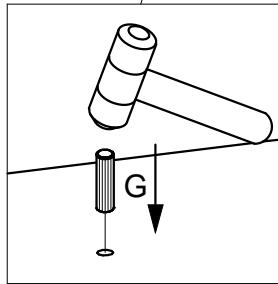
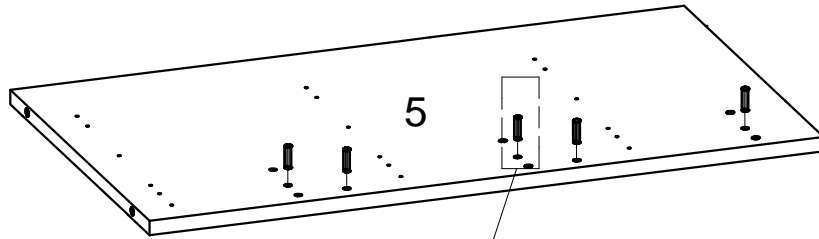
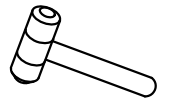
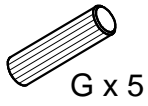

4

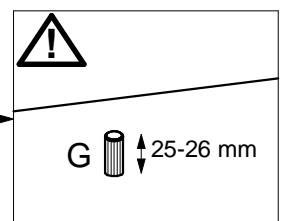
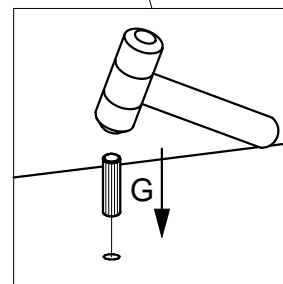
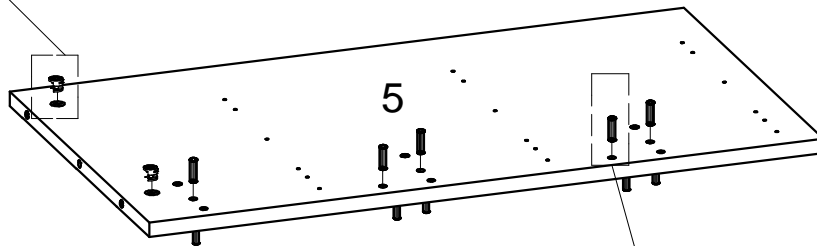
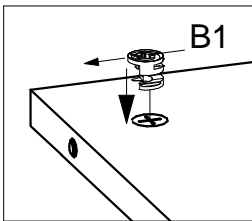
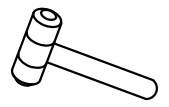
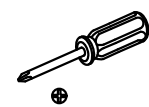
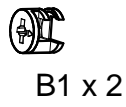
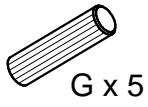

5

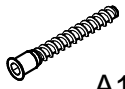

A1 x 4



A2 x 4



A3 x 1

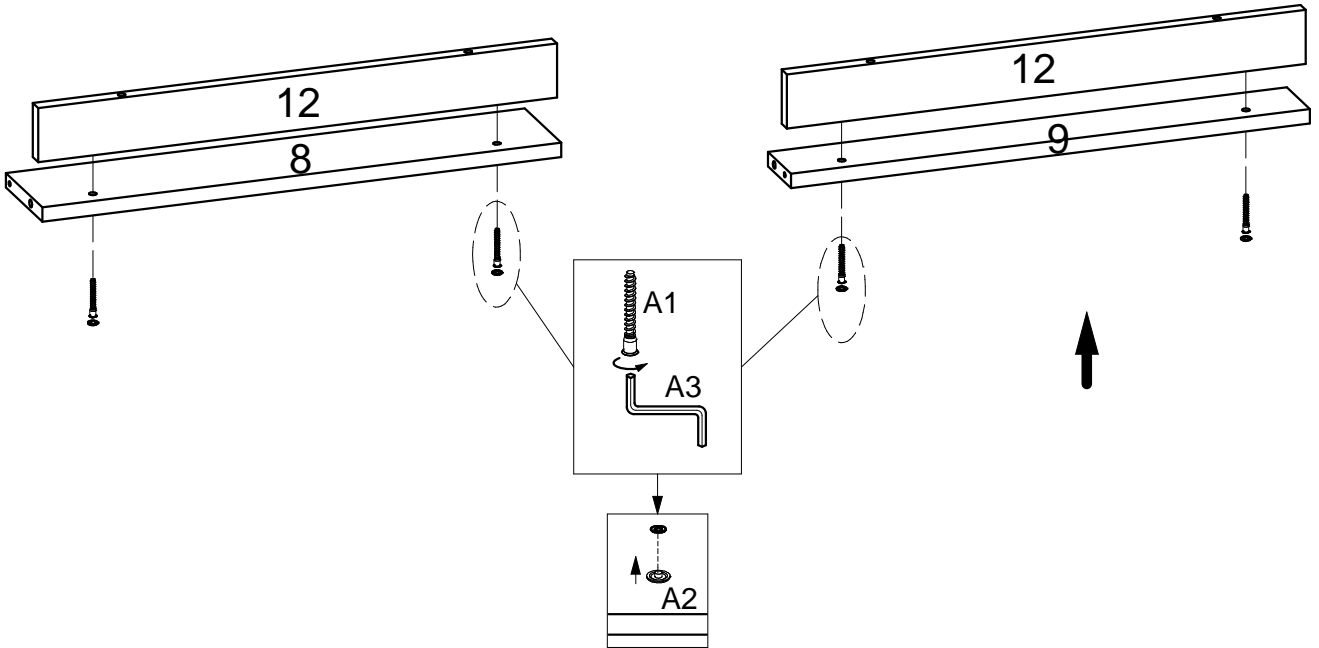

6

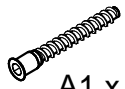

A1 x 4



A2 x 4



A3 x 1

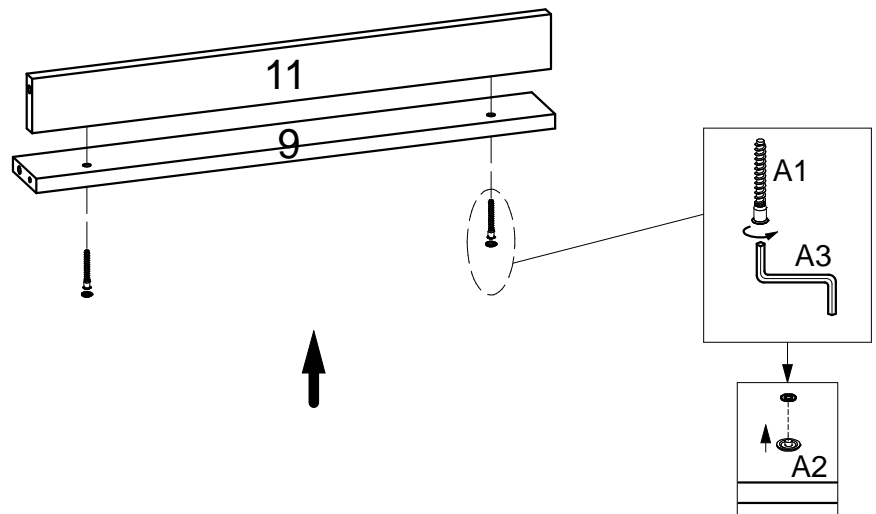

x 2

7

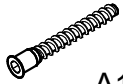

A1 x 4



A2 x 4



A3 x 1

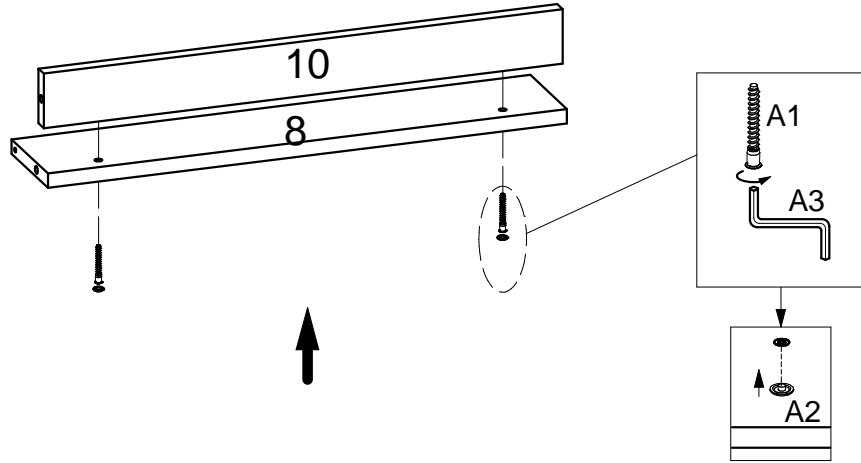

x 2

8

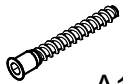

A1 x 6



A2 x 6



A3 x 1

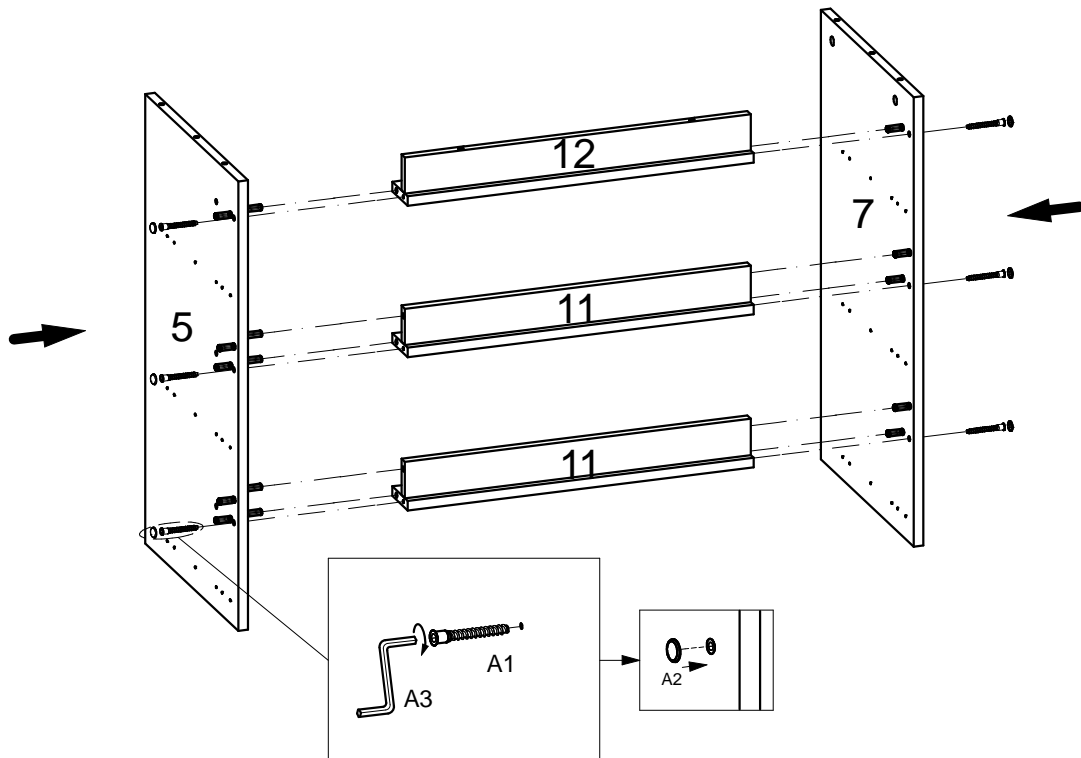
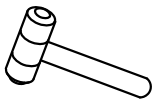

9

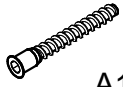

A1 x 6



A2 x 6



A3 x 1

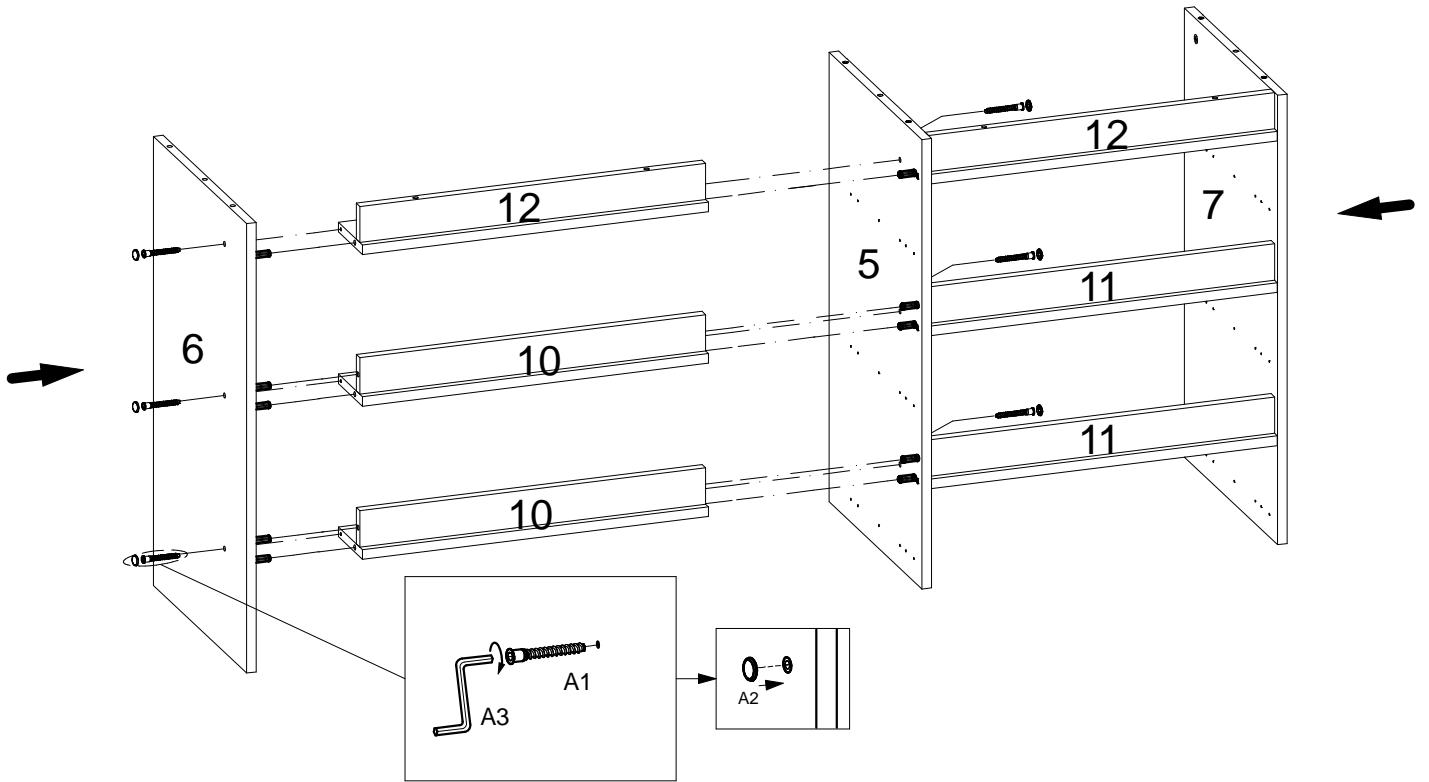
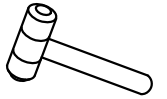

10

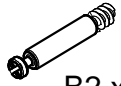

B2 x 6



G x 7

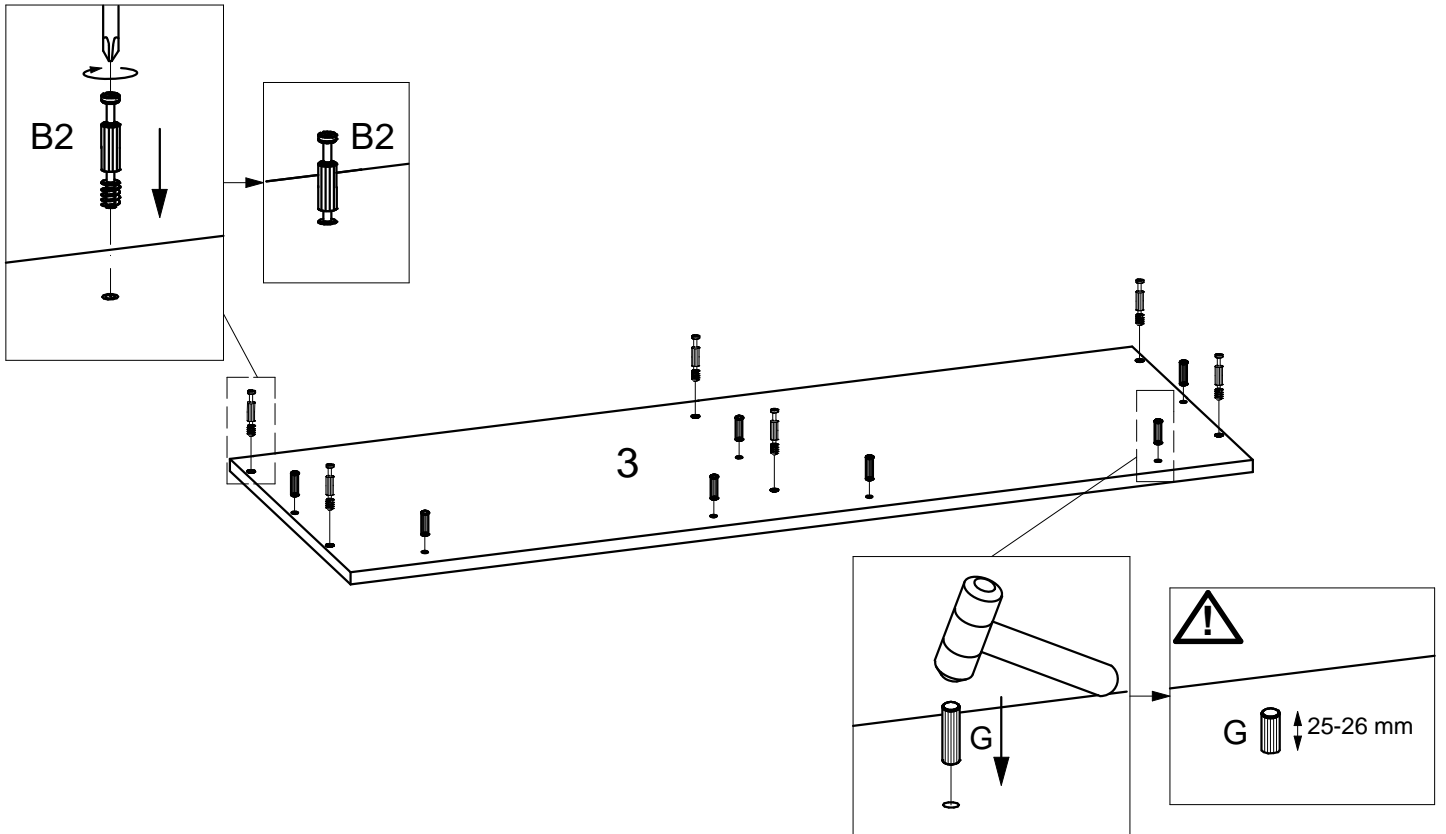
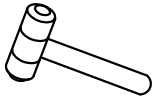
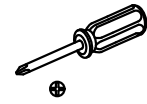

11

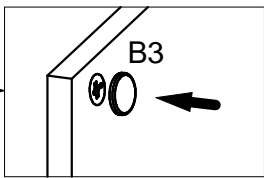
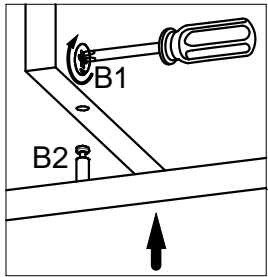
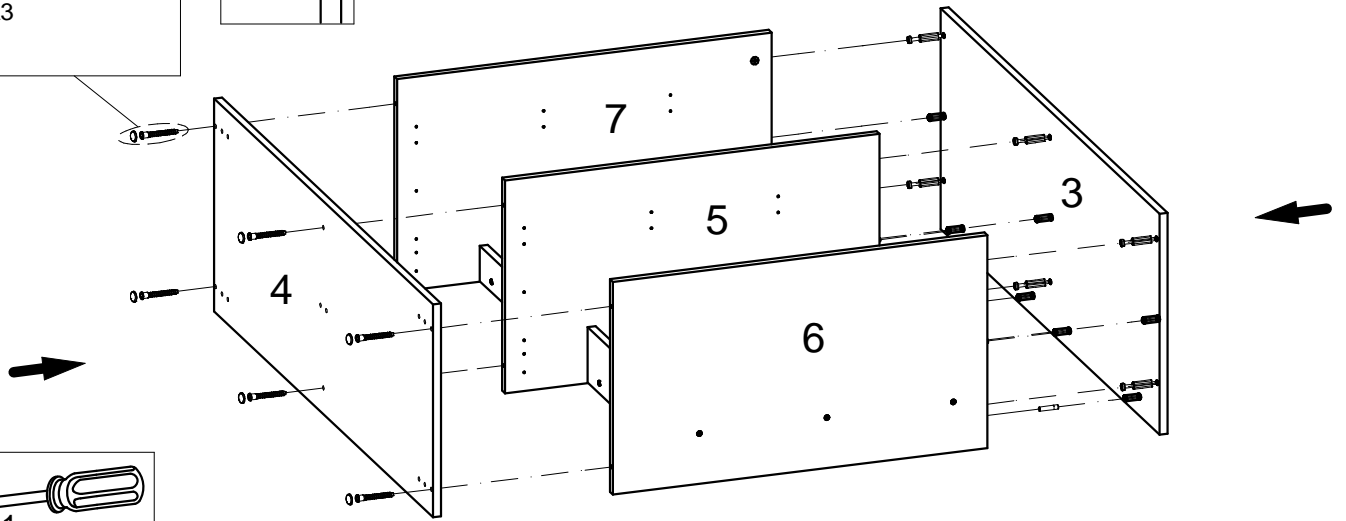
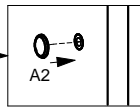
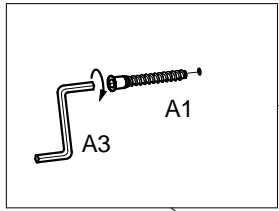
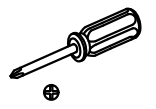
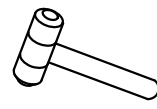
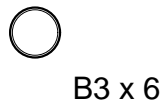
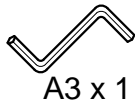
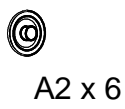

12

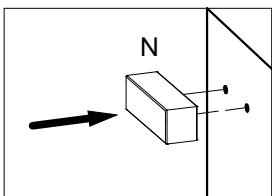
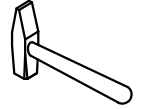
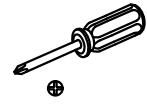
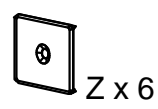
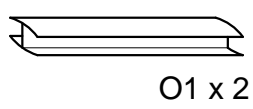
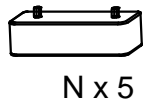
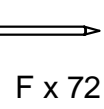
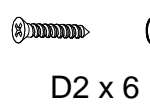

⚠ XX=YY≅90°

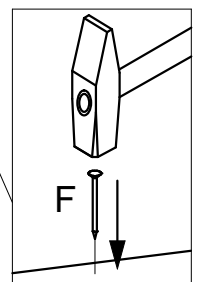
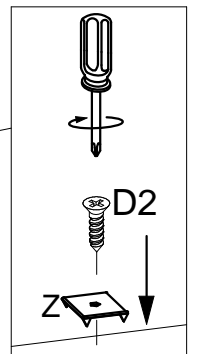
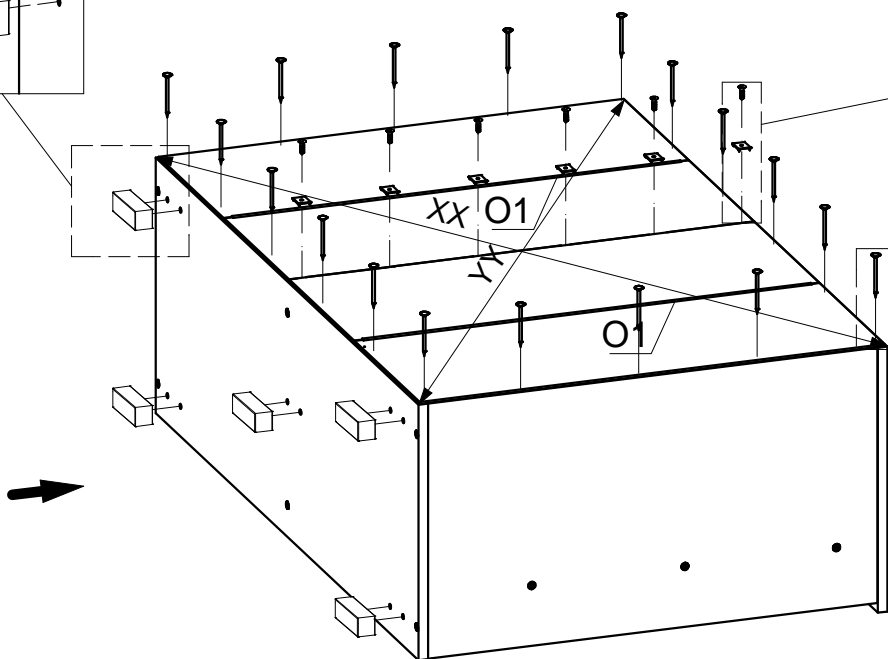

13



D1 x 36



K.1 x 6



K.2 x 6

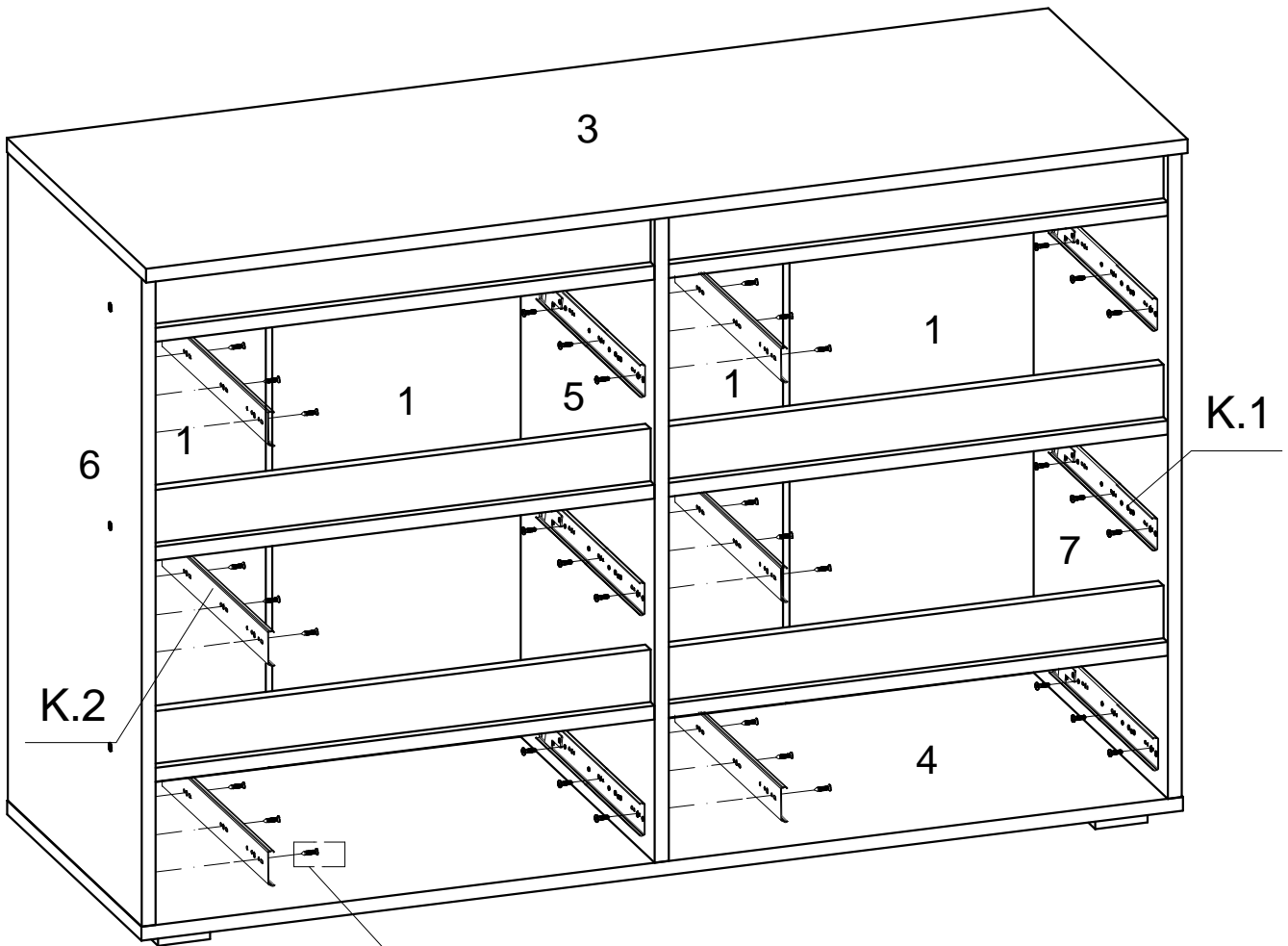
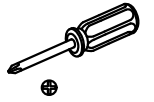

K.2

K.1

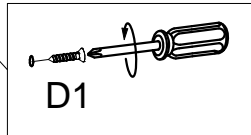

14

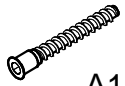

A1 x 24



A2 x 24



A3 x 1



B1 x 12

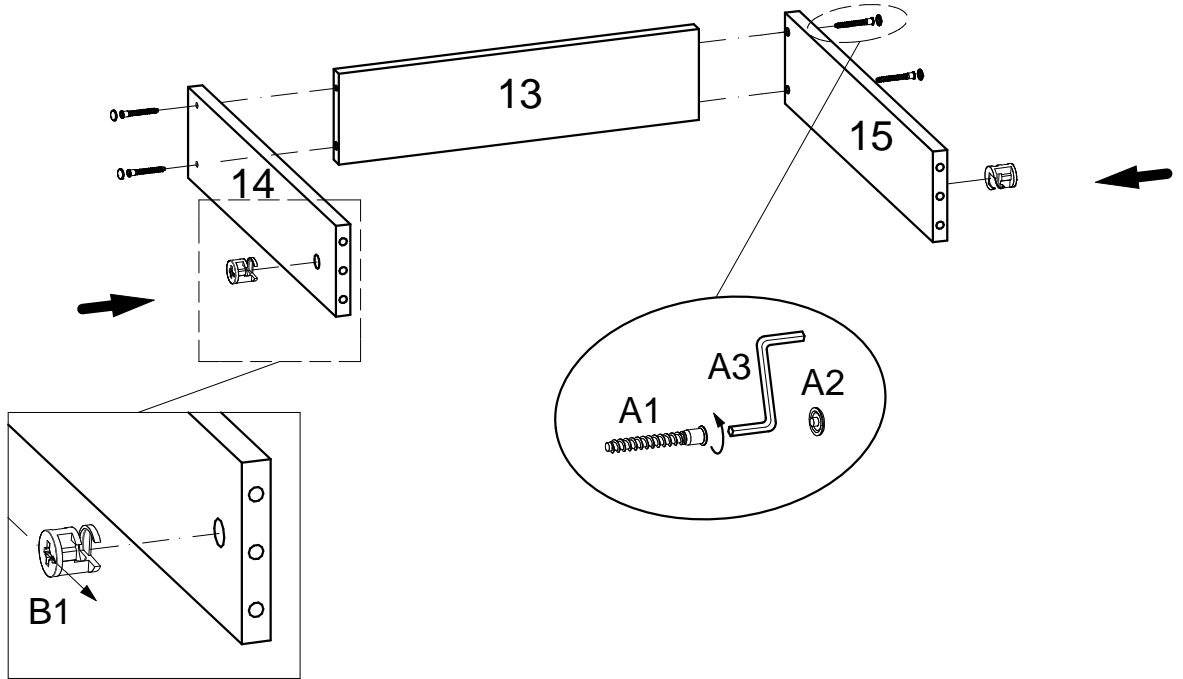

x 6

15

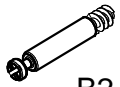

B2 x 6



B3 x 6



G x 12

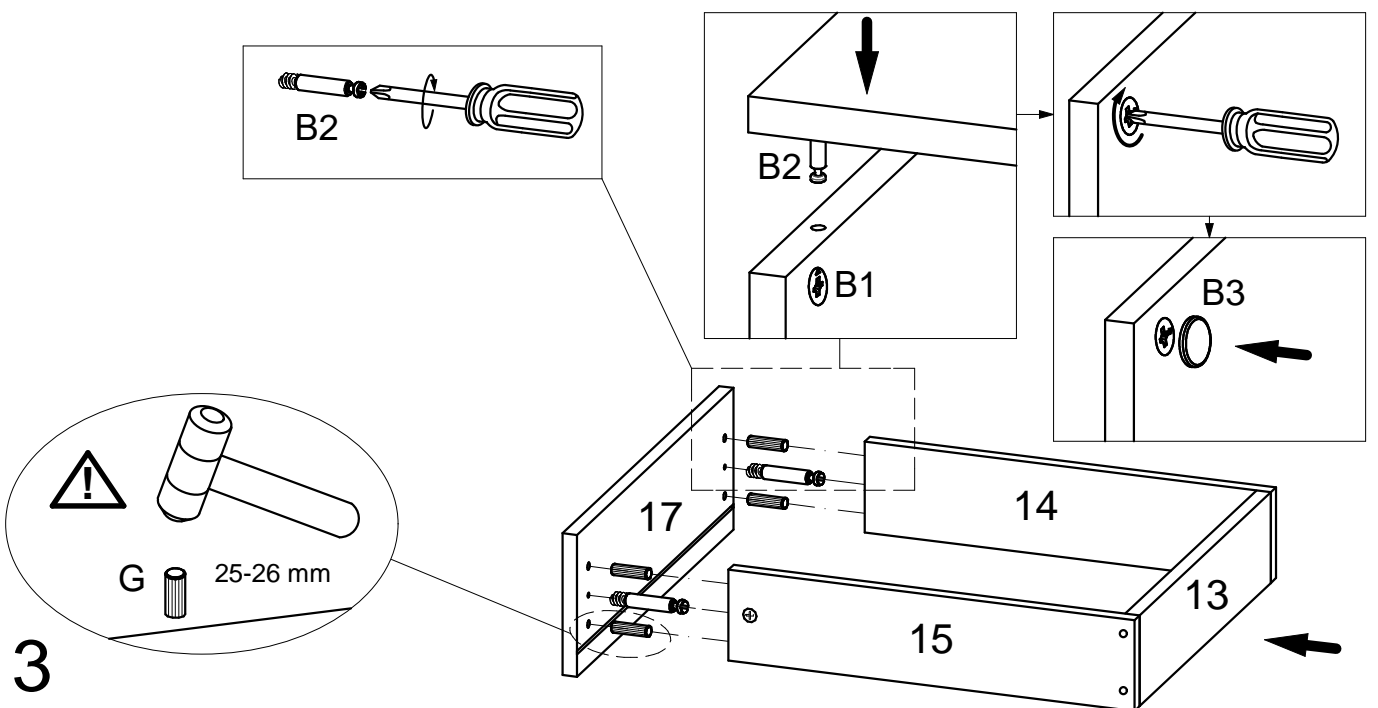
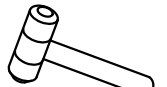
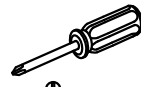

x 3

16

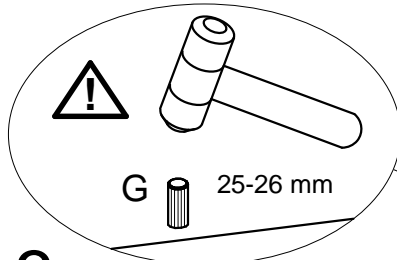
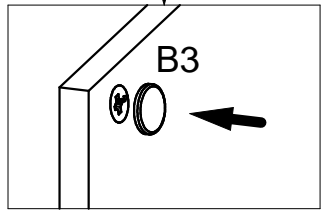
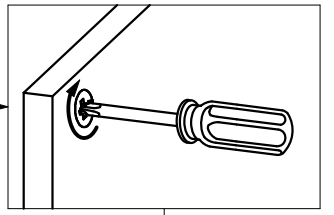
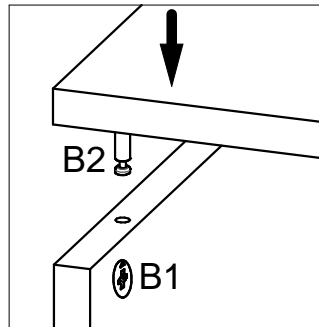
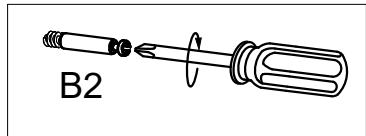
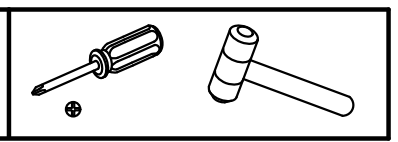
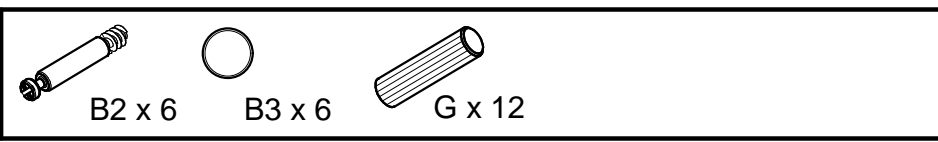

x 3

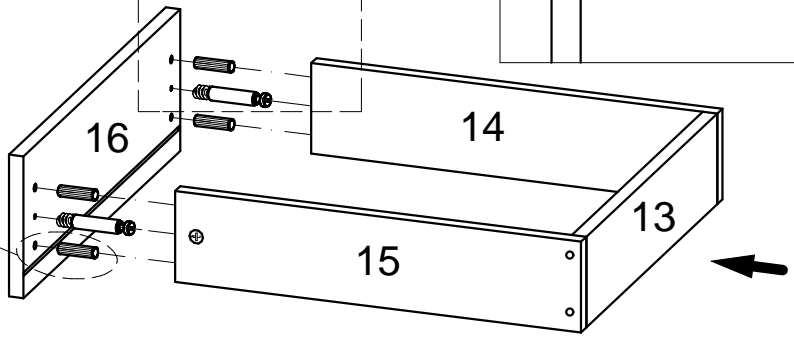

17

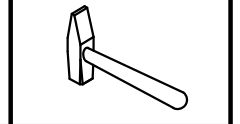

! $XX=YY \cong 90^\circ$

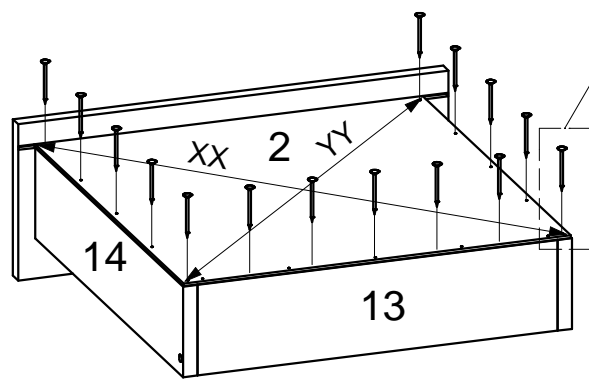
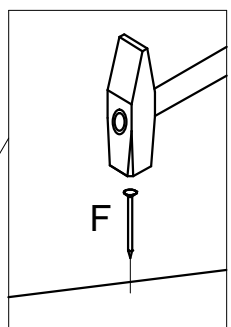

x 6

18



D1 x 18



K.3 x 3



K.4 x 3

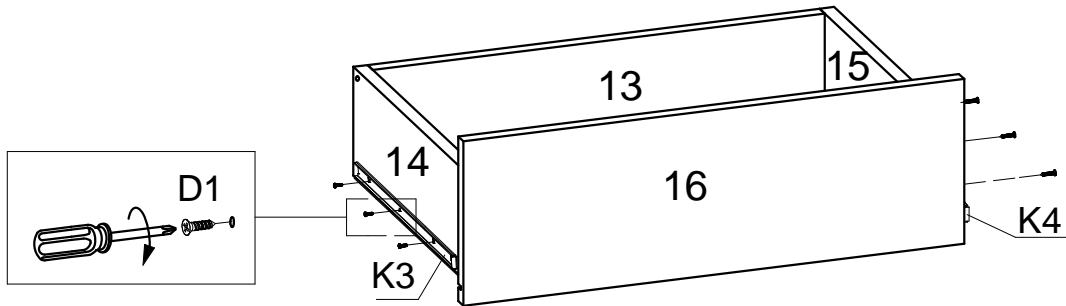
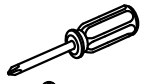

x 3

19



D1 x 18



K.3 x 3



K.4 x 3

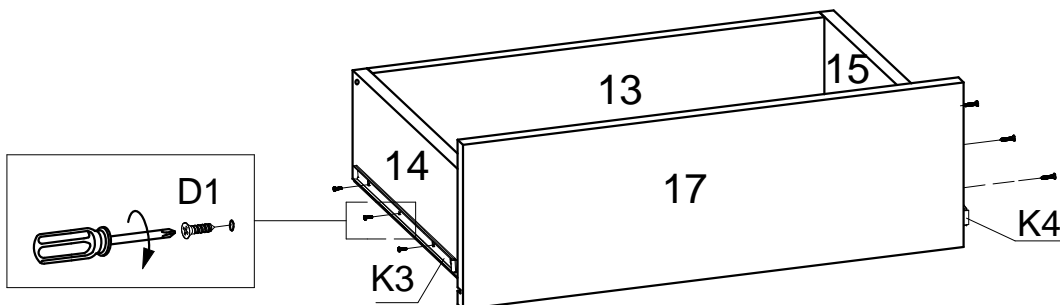
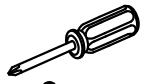

x 3

20

